

CANopen Communications Interface

Technical Manual
HA467800U002 Issue 2

Compatible with Version 2.x Software

© Copyright 2007 Parker SSD Drives, a division of Parker Hannifin Ltd.

All rights strictly reserved. No part of this document may be stored in a retrieval system, or transmitted in any form or by any means to persons not employed by a Parker SSD Drives company without written permission from Parker SSD Drives, a division of Parker Hannifin Ltd. Although every effort has been taken to ensure the accuracy of this document it may be necessary, without notice, to make amendments or correct omissions. Parker SSD Drives cannot accept responsibility for damage, injury, or expenses resulting therefrom.

WARRANTY

Parker SSD Drives warrants the goods against defects in design, materials and workmanship for the period of 12 months from the date of delivery on the terms detailed in Parker SSD Drives Standard Conditions of Sale IA058393C.

Parker SSD Drives reserves the right to change the content and product specification without notice.

Safety Information



WARNING!

During commissioning, remove the fuses (or trip the circuit breaker) on your 3-phase supply.
Make sure the power is OFF, and that it cannot be switched on accidentally whilst you are working.

REFER TO YOUR MAIN PRODUCT MANUAL FOR SPECIFIC SAFETY INFORMATION ABOUT THE DEVICE YOU ARE CONTROLLING

IMPORTANT: Please read this information BEFORE installing the equipment.

Intended Users

This manual is to be made available to all persons who are required to install, configure or service equipment described herein, or any other associated operation.

The information given is intended to highlight safety issues, EMC considerations, and to enable the user to obtain maximum benefit from the equipment.

Application Area

The equipment described is intended for industrial motor speed control.

Personnel

Installation, operation and maintenance of the equipment should be carried out by qualified personnel. A qualified person is someone who is technically competent and familiar with all safety information and established safety practices; with the installation process, operation and maintenance of this equipment; and with all the hazards involved.

Safety

All control and signal terminals are SELV, i.e. protected by double insulation.

EMC

In a domestic environment this product may cause radio interference in which case the user may be required to take adequate counter-measures.

This equipment contains electrostatic discharge (ESD) sensitive parts. Observe static control precautions when handling, installing and servicing this product.

Safety Information



CAUTION!

At any time, there may be a loss of motor control and separate/independent application measures should be taken to ensure that such loss of motor control cannot present a safety hazard.

RISK ASSESSMENT

Under fault conditions, power loss or unintended operating conditions, the drive may not operate as intended. In particular:

- Stored energy might not discharge to safe levels as quickly as suggested, and can still be present even though the drive appears to be switched off
- The motor's direction of rotation might not be controlled
- The motor speed might not be controlled
- The motor might be energised

A drive is a component within a drive system that may influence its operation or effects under a fault condition. Consideration must be given to:

- Stored energy
- Supply disconnects
- Sequencing logic
- Unintended operation

Contents

Contents

Page

CANOPEN COMMUNICATIONS INTERFACE	1
System Overview	1
• Advantages	1
• Features	1
The CANopen Protocol	1
Principles of Operation	1
Product Features	2
Product Code and Contents	2
Hardware Installation	3
Wiring the System	3
• Cable Specification	3
• Earthing the Shield	3
• User Connections to the CANopen Technology Option	4
• Terminators	4
• Terminal Block (TB1) Connections	4
Fitting and Connecting to the Technology Box	5
Wiring Diagram Example	6
Initial Check for Connection	6
Understanding the LED Indications	7
Configuring the Drive	8
The CANopen MMI View	8
The Non-specific ConfigEd-Lite & MMI View	9
EDS Files	11
Object Dictionary	12
• Communication Profile Area	12
• Manufacturer Specific Profile Area	15
• Standard Device Profile Area for DS402	16
Process Data Communication	17
PDO Behaviour	17
PDO Mapping	17
• DS402 (690+ only)	18
• PRESETS (690+ only)	18
• miniLINK (590+ only)	19
Transmit PDOs	20
Receive PDOs	20
Store Parameters (Index 1010h)	21
NMT_operational_state (Index 2018h)	21
PDO Transmit Masks (Indexes 2014h to 2017h)	21

Contents

<i>Contents</i>	<i>Page</i>
Application Parameters (Indexes 5000h to 5FFEh)	21
Enter/Exit Configuration Mode (Index 5FFFh)	22
SYNC Watchdog	22
PEER to PEER Comms.....	22
EMERGENCY Message.....	26
Troubleshooting.....	27
• 6053/6055 CANopen Technology Option Status LED	27

CANOPEN COMMUNICATIONS INTERFACE

System Overview

CANopen unleashes the full power of CAN by allowing direct peer-to-peer data exchange between nodes in an organized and, if necessary deterministic manner. The network management functions specified in CANopen simplify project design, implementation and diagnosis by providing standard mechanisms for network start-up and error management.

CANopen supports both cyclic and event driven communication. This makes it possible to reduce the bus load to a minimum but still maintaining extremely short reaction times. High communication performance can be achieved at relatively low baud rates, thus reducing electromagnetic interferences (EMI) and minimizing cable costs.

CANopen is the ideal networking system for all types of automated machinery. One of the distinguishing features of CANopen is its support for data exchange at the supervisory control level, as well as accommodating the integration of very small sensors and actuators on the same physical network. This avoids the unnecessary expense of gateways linking sensor/actuator bus systems with higher communication networks and makes CANopen particularly attractive to original equipment manufacturers.

Advantages

- Open and vendor independent
- Supports interoperability of different devices
- High-speed real-time capable
- Modularity covers simple to complex devices
- User-friendly, because of the wide variety of support tools available

Features

- Auto configuration of the network
- Easy access to all device parameters
- Device synchronisation
- Cyclic and event-driven data exchange
- Synchronous data acquisition and reaction

The CANopen Protocol

CANopen is a vendor independent, open fieldbus standard for a wide range of applications in manufacturing, process and building automation. CAN in Automation (CiA) is the international user organisation for CANopen. General CANopen information is available on the Internet: www.can-cia.de.

Principles of Operation

CANopen communication objects transmitted via the CAN network are described by the services and protocols. They are classified as follows:

- The real-time data transfer is performed by the Process Data Objects (PDOs) protocol.
- Service Data Objects (SDOs) protocols provide the read and write access to entries of a device object dictionary.
- Special Function Object protocols provide application-specific network synchronization, time stamping and emergency message transmissions.
- The Network Management (NMT) protocols provide services for network initialization, error control and device status control.

Product Features

- Suitable for use with:
 - 690+, all software versions
 - 590+ software version 5.x onwards
- Connection using shielded, twisted-pair cable
- Baud rate can be changed from 10 kbits/s up to 1 Mbit/s
- LEDs to indicate board and communications status
- Configured using Function Block inputs
- Diagnostics using Function Block outputs
- Software-selectable Node Address and Baud Rate
- Supports DS402 profile (690+ only)

Product Code and Contents

The Parker SSD Drives' product is fully identified using an alphanumeric code which records how the product was assembled, and its various settings when despatched from the factory.

The Technology Option can be supplied with the drive product, or supplied separately:

Product	Product Code when supplied with the Drive	Product Code when supplied separately
690+B	690PB /xxxx/xxx/x/x/xxxx/xxxx/xxxx/ CAN /xxxx/xxxx/xxxx	6053/CAN/00 - plug-in Technology Box
690+C-J	690P /xxxx/xxx/xxxx/xx/xxx/ CAN /xxx/xxx/xx/xxx/xxx	6055/CAN/00 - plug-in Technology Box
590+	590P /xxxx/xxx/xxxx/xx/xxx/ CAN /xxx/xxx	6055/CAN/00 - plug-in Technology Box
591P	591P /xxxx/xxx/xxxx/xx/xxx/ CAN /xxx/xxx	6055/CAN/00 - plug-in Technology Box

Hardware Installation

Wiring the System

WARNING!

Before installing, ensure that the drive and all wiring is electrically isolated and cannot be made "live" unintentionally by other personnel.

Wait 5 minutes after disconnecting power before working on any part of the system or removing the covers from the Drive.

The CANopen Option is provided in a plug-in Technology Box suitable for installing in most Parker SSD Drives products (refer to the Product Code definition on page 2).

Note: *It is possible to make serial communications operate without adhering to the following recommendations, however, the recommendations will promote greater reliability.*

Cable Specification

The media for CANopen is a shielded copper cable consisting of one twisted pair and two optional cables for an external power supply. As standard, the CANopen option does not use the external power supply. The user organisation (CiA) has specified ISO/DIS 11898 as the standard bus cable.

Maximum Cable Lengths

The maximum cable length depends on the baud rate selected:

Data Rate	Maximum Distance
20 kBit/s	800 metres
50 kBit/s	600 metres
125 kBit/s	500 metres
250 kBit/s	250 metres
500 kBit/s	100 metres
1 Mbit/s	25 metres

Earthing the Shield

The cable shield should be connected to each device on the network. Refer to the connection details on page 6.

User Connections to the CANopen Technology Option

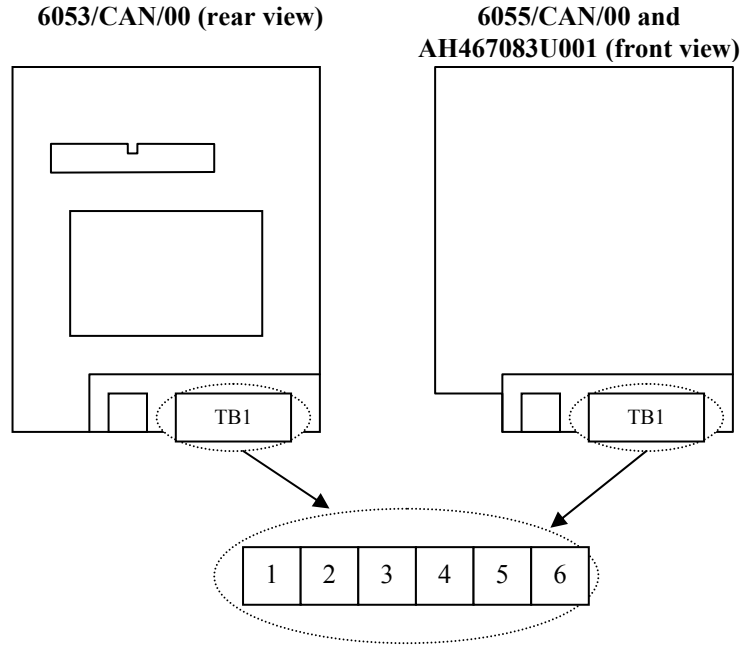

Figure 1. Option showing TB1

Note that if the 6053/CAN/00 is viewed from the front, i.e. with the CANopen label on top, the numbering of terminals is effectively reversed.

Terminators

- If the drive is at the end of the trunk it must have a terminating resistor.
- All other drives in the system should not have a terminator.

Connect terminating resistors to the last drive as shown opposite. (resistor is $\pm 1\%$, minimum $\frac{1}{4}$ Watt).

The CANopen specification recommends 124Ω , but it should be chosen to equal as closely as possible the characteristic impedance of the cable.

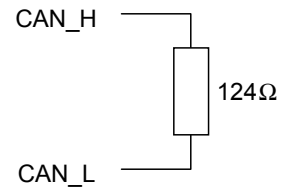

IMPORTANT: Failing to fit terminating resistors correctly may result in unreliable operation.

Terminal Block (TB1) Connections

TB1 Terminal	Reference	Meaning
1	CAN_GND	Ground / 0v
2	CAN_L	Signal connection (dominant low)
3	(CAN_SHLD)	Optional Can Shield
4	CAN_H	Signal connection (dominant high)
5	---	Not used
6	GND	Chassis Ground. On 690+B only, connect this terminal to chassis ground via 1.5mm (min) wire.

Note: Terminals 1 to 5 inclusive conform to the CANopen recommended terminal assignment for open style connector. CiA Draft Recommendation Proposal 303-1.

Fitting and Connecting to the Technology Box

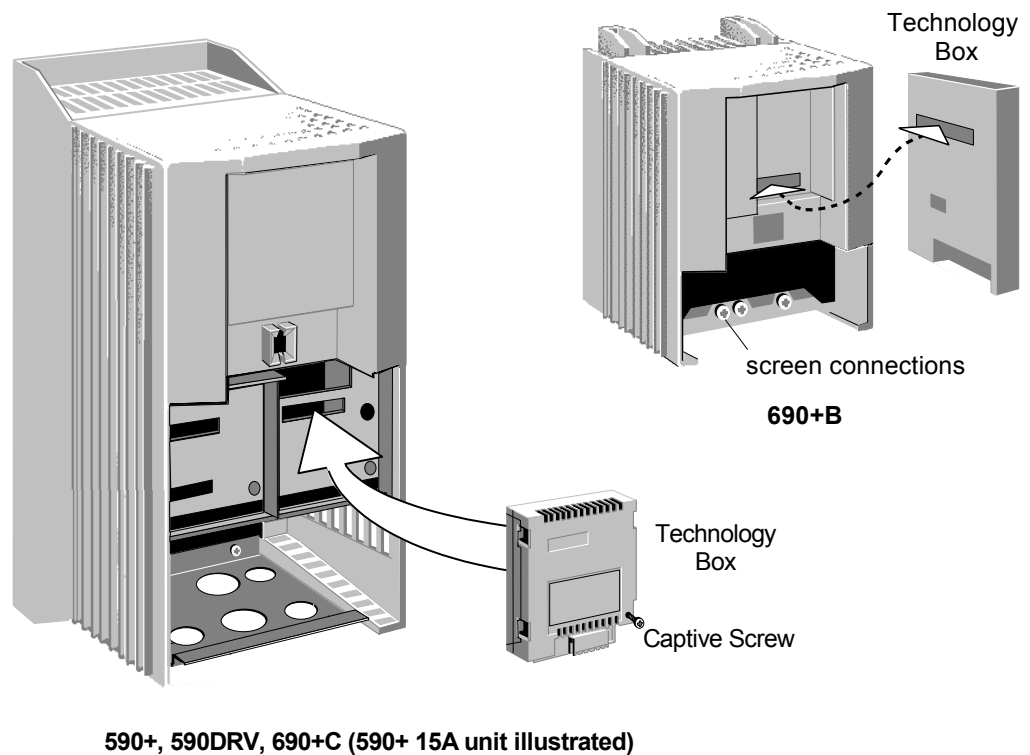

590+, 590DRV, 690+C (590+ 15A unit illustrated)

Figure 2. Plug-in Technology Boxes

WARNING!

Ensure that all wiring is isolated.

The Technology Option plugs into the right-hand position on the front of the drive, or in place of the Operator Station/blank cover (690+B only).

It can be used with the Operator Station fitted, but for the 690+B units you must mount the Operator Station remotely using the Panel Mounting Kit with connecting lead (6052/00). The connecting lead enters the 690+B drive through the gland plate.

- Remove the terminal cover and screws.
- On 690+B units, plug the ribbon cable into the back of the Technology Box and into the socket on the drive.
- Click the Technology Box into place in the recess on the front of the drive. If provided, secure in position by tightening the captive screw on the bottom right hand corner of the Option.
- Make all user wiring connections. Refer to the Wiring Diagram.
- On 690+B connect TB1 terminal 6 to the drive chassis.
- Re-fit the terminal cover securely with the screws.

Wiring Diagram Example

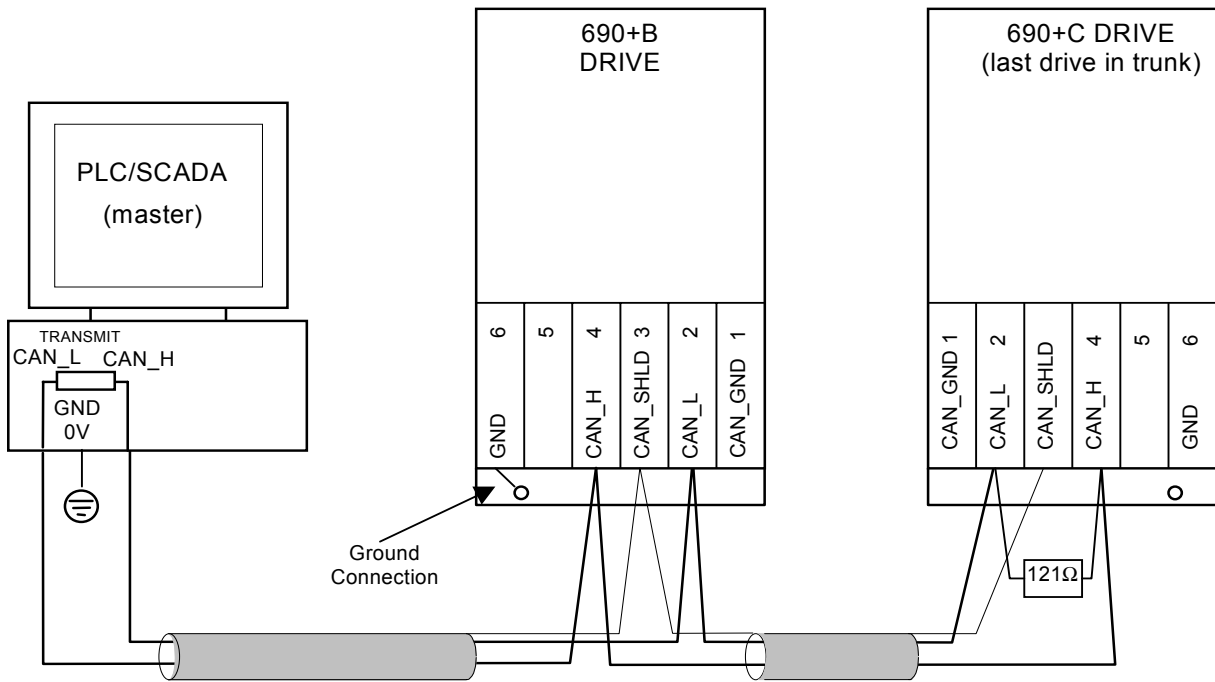

Figure 3. Typical Wiring Diagram

Note: The diagram above shows the terminal block orientation for the **FRONT-VIEW** of both Technology Boxes. Therefore the 690+ B shows terminals numbered right to left, the 690+C shows them numbered left to right.

Initial Check for Connection

With the Technology Box configured correctly, and with correct connections to the active PLC/SCADA supervisor, the MODULE LED will be ON continuously indicating the Device Operational state, and the NETWORK LED will indicate the On-Line, Not Connected state with a long flash.

ON		MODULE LED
LONG FLASH		NETWORK LED

Understanding the LED Indications

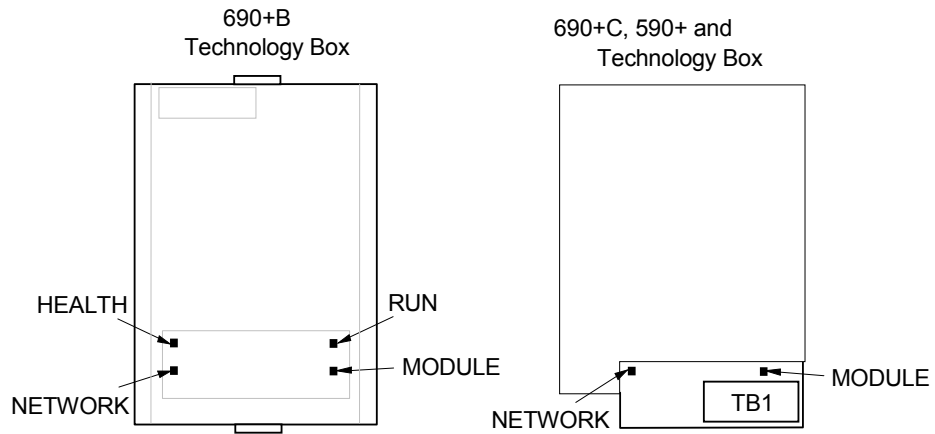

Figure 4. Technology Option LEDs

HINT: The general rule for LED indications is “ON IS GOOD, OFF IS BAD”

Health and Run LEDs (690+ Only)

These LEDs reproduce the indications of the LEDs on the drive that are hidden by the fitting of the Technology Box. 690+ B only.

Network and Module LEDs

Network LED			Module LED		
Indicates the state of the connected network. The states indicated are those produced by the NODE STATE parameter of the TEC OPTION function block.			Indicates the set-up state of the Technology Option. The states indicated are those produced by the FAULT parameter of the TEC OPTION function block.		
Network LED Indication		NODE STATE Parameter	Module LED Indication		FAULT Parameter
ON 	0	OPERATIONAL	ON 	0	NONE
LONG FLASH 	1	PRE-OPERATIONAL	LONG FLASH 	1	PARAMETER
FLASH 	2	PRE-OPERATIONAL	FLASH 	2	TYPE MISMATCH
SHORT FLASH 	4	INITIALISATION	SHORT FLASH 	3	SELF TEST
OFF 	5	DISABLED	OFF 	4	HARDWARE
			5	MISSING	

Figure 5. LED Status Indication

8

Configuring the Drive

Begin by configuring the drive to accept the Technology Option. Use the keypad (MMI), or ConfigEd Lite to configure the TEC OPTION function block parameters inside the drive before commissioning the CANopen technology option.

The parameter names and functions in this function block are inter-dependent and will change with different parameter values and various Options that can be fitted.

Fit the CANopen option to the drive:

- Navigate to select the "full menu" display on the MMI. This allows you to view the TEC OPTION function block in the SETUP PARAMETERS menu (690+) or the SERIAL LINKS menu (590+).
- Navigate to the TEC OPTION menu and:
 - ◆ set the TYPE parameter to "CANOPEN"
 - ◆ select the BIT RATE
 - ◆ enter a unique NODE ID
 - ◆ if required, select a PDO DEFAULT to determine the pre-configured PDO mappings
 - ◆ check the FAULT parameter for error messages, rectify if necessary

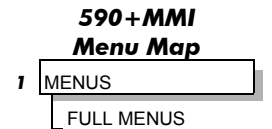
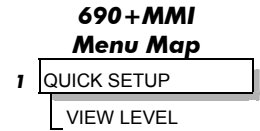

Note: When using the MMI, remember to save the set-up via the Parameter Save or Config Save menu.

When setting values for parameters from ConfigEd Lite (or other suitable PC programming tool) you are able to select any value in the parameter's range, i.e. -32768 to 32767. If the value is incorrect, i.e. it doesn't correspond to a value that can be set using the MMI, then the FAULT output parameter will be set to PARAMETER.

The CANopen MMI View

With the CANopen option correctly installed, the TEC OPTION function block will contain the following parameter names when viewed using the MMI.

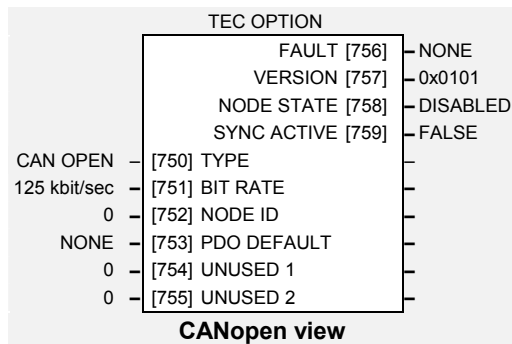

MMI Menu Map (590+)

CANopen view

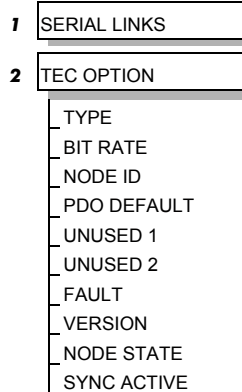

MMI Menu Map (690+)

CANopen view

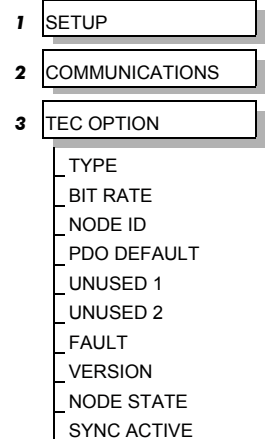

The Non-specific ConfigEd-Lite & MMI View

This is how the TEC OPTION function block looks when viewed using ConfigEd-Lite.

The MMI also displays these non-specific parameter names when the LonWorks option is not yet installed into the drive, or an incorrect TYPE is selected for the fitted Option.

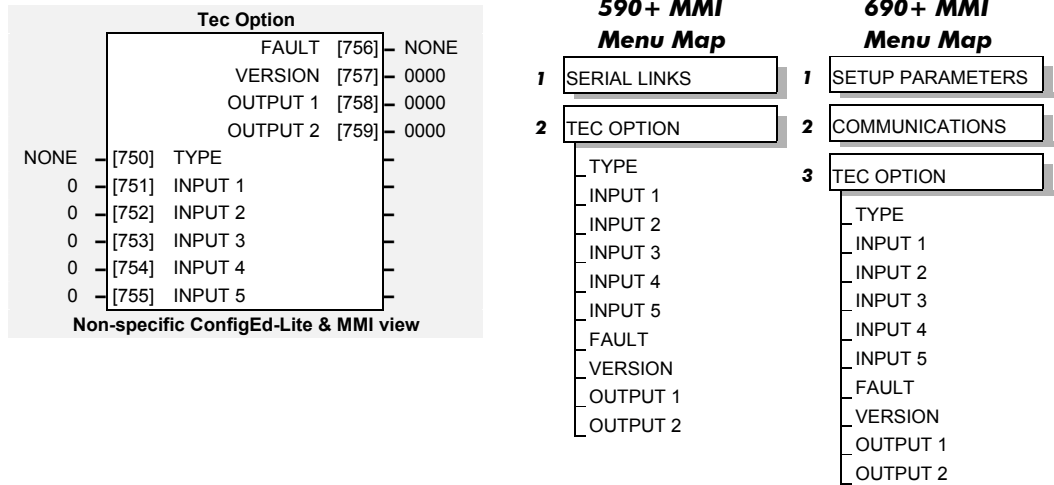

MMI Parameter Descriptions for CANopen

TEC OPTION TYPE

Range: Enumerated - see below

Selects the type of Technology Option card.

Enumerated Value : Technology Option Type

- 0 : NONE
- 1 : RS485
- 2 : PROFIBUS DP
- 3 : LINK
- 4 : DEVICENET
- 5 : CAN OPEN
- 6 : LONWORKS
- 7 : CONTROLNET
- 8 : MODBUS PLUS
- 9 : ETHERNET

BIT RATE

Range: Enumerated – see below

The CANopen baud rate.

Enumerated Value : Bit Rate

- 0 : 10 kbit/sec
- 1 : 20 kbit/sec
- 2 : 50 kbit/sec
- 3 : 100 kbit/sec
- 4 : 125 kbit/sec (default)
- 5 : 250 kbit/sec
- 6 : 500 kbit/sec
- 7 : 800 kbit/sec
- 8 : 1 Mbit/sec

NODE ID

Range: 0 to 127

The CANopen node address. Defaults to 0 (zero).

Note - setting to 0 disables the node.

MMI Parameter Descriptions for CANopen

PDO DEFAULT

Range: Enumerated – see below

The CANopen baud rate.

690+

Enumerated Value : PDO Default

- 0 : NONE (default)
- 1 : SAVED
- 2 : DS402
- 3 : PRESETS

590+

Enumerated Value : PDO Default

- 0 : NONE (default)
- 1 : SAVED
- 2 : miniLINK

This parameter defines the default PDO configuration after a power-up or reset. Refer to "PDO Mapping" on page 17 for details.

UNUSED 1

Input reserved for future use.

UNUSED 2

Input reserved for future use.

FAULT

Range: Enumerated - see below

The fault state of the Technology Option.

Enumerated Value : Fault

- 0 : NONE
- 1 : PARAMETER
- 2 : TYPE MISMATCH
- 3 : SELF TEST
- 4 : HARDWARE
- 5 : MISSING

This is the configuration state of the Technology Option. If NONE then the option is ready to communicate on the CANopen network, otherwise refer to Troubleshooting section for more details.

VERSION

Range: 0000 to FFFF

The version of the Technology Option card. If no option is fitted then the version is reset to zero.

For example, a value of 0101 indicates version 1.1

MMI Parameter Descriptions for CANopen

NODE STATE

Range: Enumerated - see below

The CANopen network state.

Enumerated Value : Node State

- 0 : OPERATIONAL
- 1 : PRE-OPERATIONAL
- 2 : STOPPED
- 3 : INITIALISATION
- 4 : DISABLED

OPERATIONAL

As defined in DS301, PDO, SDO and NMT services are active.

PRE-OPERATIONAL

As defined in DS301, only SDO and NMT services are active.

STOPPED (also known as PREPARED)

As defined in DS301, only NMT services are active.

INITIALISATION

Transient state after a reset.

DISABLED

Connection to network disabled, due to incorrect parameterisation of the option. See FAULT parameter above for reason.

SYNC ACTIVE

Range: FALSE / TRUE

This is TRUE if SYNC messages are being received within the defined cycle time. Refer to "SYNC Watchdog" on page 22.

EDS Files

EDS (Electronic Data Sheet) files are provided to simplify the CANopen network configuration. An EDS file describes the set of parameters supported by the Drive. This is used by a configuration tool, PLC or scanner to read and write parameter values using SDO services and to set-up Process Data Objects.

The following EDS files are available for download from www.SSDdrives.com:

ssd690.eds	690+ AC Frequency Inverter
ssd590.eds	590+ DC Digital Drive

Note: The option detects which product it is being used on, and so automatically supports the correct set of parameters.

Object Dictionary

The object dictionary is divided into three parts:

- Communication Profile Area (Index 1000h to 1BFFh)
- Manufacturer Specific Profile Area (Index 2000h to 5FFFh)
- Standard Device Profile Area for DS402 (Index 0x6000 to 9FFFh)

Communication Profile Area						
*PDO Mapping allowed. ¹ Saved in non-volatile memory using Index 1010h.						
Idx	SIdx	Name	Type	Attr.	Default	Notes
1000h	0	device type	Unsigned32	const	00010192h	Frequency convertor DS402
1001h*	0	error register	Unsigned8	ro	00h	
1004h	0	number of PDOs supported	Unsigned32	ro	00040004h	4 transmit and 4 receive
	1	number of synch. PDOs	Unsigned32	ro	00040004h	All can be synchronous
	2	number of asynch. PDOs	Unsigned32	ro	00040004h	All can be asynchronous
1005h	0	COB-ID SYNC	Unsigned32	rw		¹ SYNC Consumer
1006h	0	communications cycle period	Unsigned32	rw	00000000h	¹ Used by SYNC watchdog
1008h	0	manufacturer device name	Vis-String	const	“SSD Drives 690+” or “SSD Drives 590+”	Depends on host Drive
1009h	0	manufacturer hardware version	Vis-String	const	“2”	
100Ah	0	manufacturer software version	Vis-String	const	“2.1”	
100Bh	0	Node ID	Unsigned32	ro		Same as TECH OPTION function block parameter
100Ch	0	guard time	Unsigned16	rw	0000h	¹
100Dh	0	lifetime factor	Unsigned8	rw	00h	¹
1010h		store parameters				See Store Parameters section
	0	number of entries	Unsigned8	ro	3	
	1	save all parameters	Unsigned32	rw	00000001h	
	2	save communications parameters	Unsigned32	rw	00000001h	
	3	save application parameters	Unsigned32	rw	00000001h	
1011h		restore parameters				
	0	number of entries	Unsigned8	ro	3	
	1	restore all parameters	Unsigned32	rw	00000001h	
	2	restore communications parameters	Unsigned32	rw	00000001h	
	3	restore application parameters	Unsigned32	rw	00000001h	
1014h	0	COB-ID EMCY	Unsigned32	rw	00h	¹
1015h	0	Inhibit Time EMCY	Unsigned32	rw	00h	¹
1018h		Identity Object	Identity			
	0	Number of entries	Unsigned8	ro	4	
	1	Vendor ID	Unsigned32	ro	00000098h	Parker SSD Drives
	2	Product Code	Unsigned32	ro	00000690h or 00000590h	Depends on host Drive
	3	Revision Number	Unsigned32	ro		
	4	Serial Number	Unsigned32	ro		

Communication Profile Area

*PDO Mapping allowed. ¹ Saved in non-volatile memory using Index 1010h.

Idx	SIdx	Name	Type	Attr.	Default	Notes
1400h		receive PDO1 parameter	PDO Parameter			
	0	largest sub-index supported	Unsigned8	ro	5	
	1	COB-ID	Unsigned32	rw	200h + nodeID	¹
	2	transmission type	Unsigned8	rw	254	¹
	5	event timer	Unsigned16	rw	0000h	¹
1401h		receive PDO2 parameter	PDO Parameter			
	0	largest sub-index supported	Unsigned8	ro	5	
	1	COB-ID	Unsigned32	rw	300h + nodeID	¹
	2	transmission type	Unsigned8	rw	254	¹
	5	event timer	Unsigned16	rw	0000h	¹
1402h		receive PDO3 parameter	PDO Parameter			
	0	largest sub-index supported	Unsigned8	ro	5	
	1	COB-ID	Unsigned32	rw	400h + nodeID	¹
	2	transmission type	Unsigned8	rw	254	¹
	5	event timer	Unsigned16	rw	0000h	¹
1403h		receive PDO4 parameter	PDO Parameter			
	0	largest sub-index supported	Unsigned8	ro	5	
	1	COB-ID	Unsigned32	rw	500h + nodeID	¹
	2	transmission type	Unsigned8	rw	254	¹
	5	event timer	Unsigned16	rw	0000h	¹
1600h		receive PDO1 mapping parameter	PDO Mapping			
	0	number of mapped objects	Unsigned8	rw	0	¹ Maximum 4
	1	1 st mapped object	Unsigned32	rw	00000000h	¹
	2	2 nd mapped object	Unsigned32	rw	00000000h	¹
	3	3 rd mapped object	Unsigned32	rw	00000000h	¹
	4	4 th mapped object	Unsigned32	rw	00000000h	¹
1601h		receive PDO2 parameter	PDO Parameter			
	0	number of mapped objects	Unsigned8	rw	0	¹ Maximum 4
	1	1 st mapped object	Unsigned32	rw	00000000h	¹
	2	2 nd mapped object	Unsigned32	rw	00000000h	¹
	3	3 rd mapped object	Unsigned32	rw	00000000h	¹
	4	4 th mapped object	Unsigned32	rw	00000000h	¹
1602h		receive PDO3 parameter	PDO Parameter			
	0	number of mapped objects	Unsigned8	rw	0	¹ Maximum 4
	1	1 st mapped object	Unsigned32	rw	00000000h	¹
	2	2 nd mapped object	Unsigned32	rw	00000000h	¹
	3	3 rd mapped object	Unsigned32	rw	00000000h	¹
	4	4 th mapped object	Unsigned32	rw	00000000h	¹
1603h		receive PDO4 parameter	PDO Parameter			
	0	number of mapped objects	Unsigned8	rw	0	¹ Maximum 4
	1	1 st mapped object	Unsigned32	rw	00000000h	¹
	2	2 nd mapped object	Unsigned32	rw	00000000h	¹
	3	3 rd mapped object	Unsigned32	rw	00000000h	¹
	4	4 th mapped object	Unsigned32	rw	00000000h	¹

Communication Profile Area

*PDO Mapping allowed. ¹ Saved in non-volatile memory using Index 1010h.

Idx	SIdx	Name	Type	Attr.	Default	Notes
1800h		transmit PDO1 parameter	PDO Parameter			
	0	largest sub-index supported	Unsigned8	ro	5	
	1	COB-ID	Unsigned32	rw	180h + nodeID	¹
	2	transmission type	Unsigned8	rw	253	¹
	3	inhibit time	Unsigned16	rw	0000h	¹
	5	event timer	Unsigned16	rw	0000h	¹
1801h		transmit PDO2 parameter	PDO Parameter			
	0	largest sub-index supported	Unsigned8	ro	5	
	1	COB-ID	Unsigned32	rw	280h + nodeID	¹
	2	transmission type	Unsigned8	rw	253	¹
	3	inhibit time	Unsigned16	rw	0000h	¹
	5	event timer	Unsigned16	rw	0000h	¹
1802h		transmit PDO3 parameter	PDO Parameter			
	0	largest sub-index supported	Unsigned8	ro	5	
	1	COB-ID	Unsigned32	rw	380h + nodeID	¹
	2	transmission type	Unsigned8	rw	253	¹
	3	inhibit time	Unsigned16	rw	0000h	¹
	5	event timer	Unsigned16	rw	0000h	¹
1803h		transmit PDO4 parameter	PDO Parameter			
	0	largest sub-index supported	Unsigned8	ro	5	
	1	COB-ID	Unsigned32	rw	480h + nodeID	¹
	2	transmission type	Unsigned8	rw	253	¹
	3	inhibit time	Unsigned16	rw	0000h	¹
	5	event timer	Unsigned16	rw	0000h	¹
1A00h		transmit PDO1 mapping parameter	PDO Mapping			
	0	number of mapped objects	Unsigned8	rw	0	¹ Maximum 4
	1	1 st mapped object	Unsigned32	rw	00000000h	¹
	2	2 nd mapped object	Unsigned32	rw	00000000h	¹
	3	3 rd mapped object	Unsigned32	rw	00000000h	¹
	4	4 th mapped object	Unsigned32	rw	00000000h	¹
1A01h		transmit PDO2 parameter	PDO Parameter			
	0	number of mapped objects	Unsigned8	rw	0	¹ Maximum 4
	1	1 st mapped object	Unsigned32	rw	00000000h	¹
	2	2 nd mapped object	Unsigned32	rw	00000000h	¹
	3	3 rd mapped object	Unsigned32	rw	00000000h	¹
	4	4 th mapped object	Unsigned32	rw	00000000h	¹
1A02h		transmit PDO3 parameter	PDO Parameter			
	0	number of mapped objects	Unsigned8	rw	0	¹ Maximum 4
	1	1 st mapped object	Unsigned32	rw	00000000h	¹
	2	2 nd mapped object	Unsigned32	rw	00000000h	¹
	3	3 rd mapped object	Unsigned32	rw	00000000h	¹
	4	4 th mapped object	Unsigned32	rw	00000000h	¹
1A03h		transmit PDO4 parameter	PDO Parameter			
	0	number of mapped objects	Unsigned8	rw	0	¹ Maximum 4
	1	1 st mapped object	Unsigned32	rw	00000000h	¹
	2	2 nd mapped object	Unsigned32	rw	00000000h	¹
	3	3 rd mapped object	Unsigned32	rw	00000000h	¹
	4	4 th mapped object	Unsigned32	rw	00000000h	¹

Manufacturer Specific Profile Area						
Idx	SIdx	Name	Type	Attr.	Default	Notes
2014h		PDO1 transmit mask				
	0	number of entries	Unsigned8	ro	2	
	1	mask low	Unsigned32	rw	FFFFFFFFh	¹
	2	mask low	Unsigned32	rw	FFFFFFFFh	¹
2015h		PDO2 transmit mask				
	0	number of entries	Unsigned8	ro	2	
	1	mask low	Unsigned32	rw	FFFFFFFFh	¹
	2	mask low	Unsigned32	rw	FFFFFFFFh	¹
2016h		PDO3 transmit mask				
	0	number of entries	Unsigned8	ro	2	
	1	mask low	Unsigned32	rw	FFFFFFFFh	¹
	2	mask low	Unsigned32	rw	FFFFFFFFh	¹
2017h		PDO4 transmit mask				
	0	number of entries	Unsigned8	ro	2	
	1	mask low	Unsigned32	rw	FFFFFFFFh	
	2	mask low	Unsigned32	rw	FFFFFFFFh	
2018h	0	NMT_operational state	Unsigned16	rw	0000h	¹
<p>All 690+ and 590= tags are mapped to indexes for SDO and PDO access Index = 5000h + Tag number , Sub-Index is always 0 Boolean and Enumerated Tags are represented as Unsigned8 CANopen Objects. All allow PDO mapping, except for STRING Tags. For example (690+):</p>						
515Bh	0	(347) preset 1::input 0	Integer16	rw	0	
515Ch	0	(348) preset 1::input 1	Integer16	rw	0	
515Dh	0	(349) preset 1::input 2	Integer16	rw	0	
515Eh	0	(350) preset 1::input 3	Integer16	rw	0	
515Fh	0	(351) preset 1::input 4	Integer16	rw	0	
5160h	0	(352) preset 1::input 5	Integer16	rw	0	
5161h	0	(353) preset 1::input 6	Integer16	rw	0	
5162h	0	(354) preset 1::input 7	Integer16	rw	0	
5163h	0	(355) preset 1::select input	Unsigned8	rw	00h	
5164h	0	(356) preset 1::output	Integer16	ro	0	
5162h	0	(354) preset 1::input 7	Integer16	rw	0	
5256h	0	(598) multiplexer 1::output	Unsigned16	ro	0000h	
5257h	0	(599) demultiplexer 1::input	Unsigned16	rw	0000h	
5281h	0	(641) multiplexer 1::input 0	Unsigned8	rw	0000h	
5291h	0	(657) demultiplexer 1::output 1	Unsigned8	ro	0000h	
5FFFh	0	plng1 command	Unsigned32	wo	--	See "Enter/Exit Configuration Mode (Index 5FFFh)", page 22

Standard Device Profile Area for DS402

Idx	SIdx	Name	Type	Attr.	Default	Notes
690+ only : ALL are PDO mappable except *						
6040h	0	controlword	Unsigned16	rw	0000h	(tag 271)
6041h	0	statusword	Unsigned16	ro	0000h	(tag 272)
6042h	0	vl_target_velocity	Integer16	rw	0	RPM [†] (tag 269 as %)
6043h	0	vl_velocity_demand	Integer16	ro	0	RPM [†] (tag 255 as %)
6044h	0	vl_control_effort	Integer16	ro	0	RPM [†] (tag 569)
6046h		vl_velocity_min_max_amount	ARRAY			
	1	vl_velocity_min_amount	Unsigned32	rw	1650	RPM [†] (tag 253 as +%)
	2	vl_velocity_max_amount	Unsigned32	rw	1650	RPM [†] (tag 252 as %)
6048h		vl_velocity_acceleration	RECORD			
	1	delta_speed	Unsigned32	rw	15000	RPM [†] (tag 62 as Hz/s)
	2	delta_time	Unsigned16	ro	1	Second
6049h		vl_velocity_deceleration	RECORD			
	1	delta_speed	Unsigned32	rw	15000	RPM [†] (tag 61 as Hz/s)
	2	delta_time	Unsigned16	ro	1	Second
604Ch *		vl_velocity_dimension_factor	ARRAY			
	1	numerator	Integer32	rw	1	
	2	denominator	Integer32	rw	1	
6060h	0	modes_of_operation	Unsigned8	rw	2	Velocity Mode only supported
6061h	0	modes_of_operation_display	Unsigned8	ro	2	
6072h	0	max_torque	Unsigned16	rw	15000	xxx.xx% (tag 1210)
6078h	0	current_actual_value	Integer16	ro	0	xxx.xx% (tag 66)
60F9h		velocity_control_parameter-set	RECORD			
	1	gain	Unsigned16	rw	2000	xxx.xx (tag 1187)
	2	integration_time_const	Unsigned16	rw	100	xxxxx ms (tag 1188)

[†] Velocity units are RPM if velocity_dimension_factor (604Ch) is set to default values.

For Example, to change the Velocity units to be 0.1 RPM, set:

Numerator (sub-index 1) = 1 and Denominator (sub_index 2) to 10

Process Data Communication

All real-time data are transferred using the Process Data Objects. CANopen has defined the default settings for the data content and behaviour, but this can be altered by the user.

The CANopen option supports four Receive PDOs and four Transmit PDOs. All can be configured to exchange up to eight Drive parameters (maximum 8 bytes of data).

PDO Behaviour

The PDO communication parameters (Index 1400h to 1403h and 1800h to 1803h) describe the behaviour of a PDO. This includes the transmission type, inhibit time and event timer.

PDO Mapping

The PDO mapping parameters (Index 1600h to 1603h and 1A00h to 1A03h) define which parameters within the Drive are read or written using the PDOs. For each PDO up to eight Drive parameters may be nominated but the total amount of data cannot exceed 8 bytes. [Note - Boolean and Enumerated values require 1 byte, all other data types require 2 bytes. Parameters of type String are not mappable.]

The mapping is either determined by the default selected (see PDO DEFAULT) or is sent from a CANopen "master" when in the PRE-OPERATIONAL state. The "master" configuration tool is used together with the EDS file supplied with this option to define this mapping, e.g. using the Hilscher SYCON tool from www.hilscher.com:

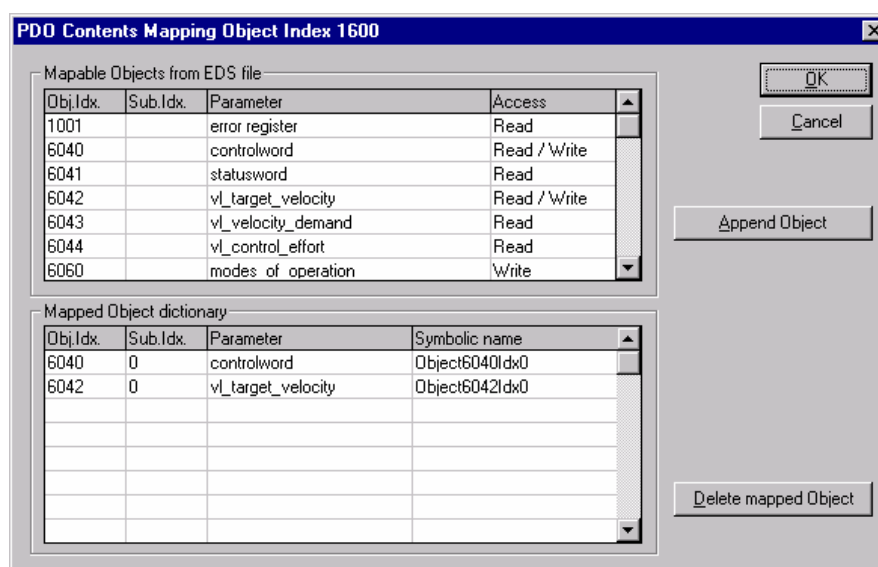

The available defaults depend on the type of Drive the option is being used on:

Drive Type	PDO DEFAULT	Purpose
Any	NONE	No mappings defined
Any	SAVED	As saved in the non-volatile memory on the option
690+	DS402	Rx PDOs 1 and 2 and Tx PDOs 1 and 2 as defined in DS402.
690+	PRESETS	General purpose access to the block diagram using Preset, Multiplexer and Demultiplexer function blocks.
590+	miniLINK	General purpose access to the block diagram using miniLink value and miniLink logic parameters.

DS402 (690+ only)**PDO 1 Tx**

Offset	Index	Sub-Index	Parameter	Type
0	6041h	0	statusword	Unsigned16

Transmission Type is Standard Device Profile (255). This causes this PDO to be transmitted asynchronously whenever the value of statusword changes.

PDO 2 Tx

Offset	Index	Sub-Index	Parameter	Type
0	6041h	0	statusword	Unsigned16
2	6044h	0	vl_control_effort	Integer16

Transmission Type is Asynchronous RTR Only (253).

PDO 1 Rx

Offset	Index	Sub-Index	Parameter	Type
0	6041h	0	controlword	Unsigned16

PDO 2 Rx

Offset	Index	Sub-Index	Parameter	Type
0	6040h	0	controlword	Unsigned16
2	6042h	0	vl_target_velocity	Integer16

PRESETS (690+ only)**PDO 1 Tx**

Offset	Index	Sub-Index	Parameter	Type
0	5256h	0	(598) multiplexer 1::output	Unsigned16
2	517Ch	0	(380) preset 2::input 0	Integer16
4	517Dh	0	(381) preset 2::input 1	Integer16
6	5369h	0	(873) multiplexer 2::output	Unsigned16

PDO 2 Tx

Offset	Index	Sub-Index	Parameter	Type
0	515Fh	0	(384) preset 2::input 4	Integer16
2	5160h	0	(385) preset 2::input 5	Integer16
4	5161h	0	(386) preset 2::input 6	Integer16
6	5162h	0	(387) preset 2::input 7	Integer16

PDO 1 Rx

Offset	Index	Sub-Index	Parameter	Type
0	5257h	0	(599) demultiplexer 1::input	Unsigned16
2	515Bh	0	(347) preset 1::input 0	Integer16
4	515Ch	0	(348) preset 1::input 1	Integer16
6	536Ah	0	(874) demultiplexer 2::input	Unsigned16

PDO 2 Rx

Offset	Index	Sub-Index	Parameter	Type
0	515Fh	0	(351) preset 1::input 4	Integer16
2	5160h	0	(352) preset 1::input 5	Integer16
4	5161h	0	(353) preset 1::input 6	Integer16
6	5362h	0	(354) preset 1::input 7	Integer16

miniLINK (590+ only)**PDO 1 Tx**

Offset	Index	Sub-Index	Parameter	Type
0	517Bh	0	(379) minilink::value 8	Integer16
2	517Ch	0	(380) minilink::value 9	Integer16
4	517Dh	0	(381) minilink::value 10	Integer16
6	517Eh	0	(382) minilink::value 11	Integer16

PDO 2 Tx

Offset	Index	Sub-Index	Parameter	Type
0	517Fh	0	(383) minilink::value 12	Integer16
2	5180h	0	(384) minilink::value 13	Integer16
4	5181h	0	(385) minilink::value 14	Integer16
6	515Ch	0	(348) minilink::logic 3	Unsigned8

PDO 1 Rx

Offset	Index	Sub-Index	Parameter	Type
0	5153h	0	(339) minilink::value 1	Integer16
2	5154h	0	(340) minilink::value 2	Integer16
4	5155h	0	(341) minilink::value 3	Integer16
6	5156h	0	(342) minilink::value 4	Integer16

PDO 2 Rx

Offset	Index	Sub-Index	Parameter	Type
0	5157h	0	(343) minilink::value 5	Integer16
2	5158h	0	(344) minilink::value 6	Integer16
4	5159h	0	(345) minilink::value 7	Integer16
6	515Ah	0	(346) minilink::logic 1	Unsigned8

Transmit PDOs

The following trigger modes are supported:

Event driven

Transmission Type (sub-index 2) 0, 254 or 255.

By default, if any of the data in the Tx PDO changes value, the PDO will be transmitted. If Transmission Type 0 is selected, this will be after the next SYNC message is received, otherwise it will be transmitted immediately. It is possible to set a mask so that some bits in the PDO can be ignored when detecting change. To do this, see vendor specific Indexes 2014h to 2017h.

Also, for rapidly changing data, it is possible to limit the number of transmitted messages by setting the Inhibit Time (sub-index 3) to specify a minimum time period between two PDO transmissions.

Polling by using Remote Frames (RTR)

All Tx PDOs can be polled using RTR.

Synchronised

Transmission Type (sub-index 2) 0 to 240, or 253.

Type 0 means the message shall be transmitted synchronously with the SYNC, but only if the change in value event has occurred.

Types 1 to 240 mean that the PDO is transmitted cyclically after the requested number of SYNCs. For example, every SYNC if Type 1, every 5 SYNCs if Type 5.

Type 253 causes the data to be captured (but not sent) on the SYNC and the transmitted when requested by the RTR.

Timer driven

Transmission Type (sub-index 2) 0, 254 or 255.

Set Event Timer (sub-index 5) to non-zero. This defines a cycle time in 1ms intervals.

When the time elapses, the PDO will be transmitted. If Transmission Type 0 is selected, this will be after the next SYNC message is received, otherwise it will be transmitted immediately.

This is in addition to transmissions caused by the "change in data" event described above. All transmissions, including those requested by an RTR, reload the timer.

Receive PDOs

For Transmission Types 0 to 240 the update is always triggered by the following SYNC.

For other Types the update will occur on reception.

Independent of the transmission Type, the Event Timer (sub-index 5) can be used to detect the expiration of the Rx PDO. When set to a non-zero value, a timeout will occur after the specified number of milliseconds if there has been no update of the PDO within that time. On a timeout the PDO data is cleared to zeros. This feature is useful when implementing simple Peer-to-Peer configurations. See "PEER to PEER Comms", page 22.

Store Parameters (Index 1010h)

Communications Parameters

Writing the value 73617665h ('s','a','v','e') to Index 1010h Sub-Index 1 or Sub-Index 2 will cause the Comms parameters to be stored in the non-volatile memory on the option card. These values are restored at power-up/reset if the PDO MAPPING Function Block input parameter is set to SAVED. In addition to the Indexes highlighted for saving in the Communication Profile Area, a few additional Indexes from the Manufacturer Specific Profile Area and Standard Device Profile Area are also saved. These parameters are:

2014h to 2016h	- PDO transmit masks
2018h	- NMT_operational state
604Ch	- vl_velocity_dimension_factor

Applications Parameters

Writing the value 73617665h ('s','a','v','e') to Index 1010h Sub-Index 1 or Sub-Index 3 will cause the Application parameters stored in the non-volatile memory on the Drive. This has the same effect as performing the save operation using the built-in Operator Station. These values are restored at power-up/reset.

NMT_operational_state (Index 2018h)

The NMT_operational_state parameter allows the node to automatically go to OPERATING state without the need for an NMT master to issue a START command. Note - this has the same functionality as the 631/635 Servo Drives.

The parameter (Index 2018) must be set to 0001 at power-up/reset for the automatic transition from PRE-OPERATIONAL state to OPERATION state. Also the PDO MAPPING Function Block input parameter must be set to SAVED.

This parameter can only be written to over CANOpen, it does not appear on the Operator Station. After writing, it must be saved in non-volatile memory by sending the Store Parameter message (SDO write to Index 1010).

PDO Transmit Masks (Indexes 2014h to 2017h)

The "on change" transmit event for PDOs can be modified by these indexes. By default, all data in a PDO is considered when checking for change. The mask allows some, or all, of the bits to be ignored.

Each Index has 2 Sub-Indexes. Sub-Index 1 is used to mask (or reveal) bits in the lower 32bits (4bytes) of data. Sub-Index 2 is the same for the upper 32bits.

For example:

Tx PDO 1 is used to transmit the statusword (Index 6041). Bit 3 of this indicates that the Drive has tripped. To prevent the PDO being transmitted when this bit changes state, a mask of FFFFFFF7h is written to Index 2014h Sub-Index 1.

Note- these parameters can only be set over CANopen. They do not appear on the Operator Station. Normally they are downloaded from a NMT master during the PRE-OPERATIONAL stage of the bus initialisation. Indexes 2014h, 2015h and 2016h are saved with the Communications Parameters in the non-volatile memory on the option.

Application Parameters (Indexes 5000h to 5FFeh)

In addition to the DS402 (690+only) Indexes, all parameters (tags) within the Drive can be accessed using SDO or PDO messages.

The Index is 5000h + tag number with Sub-Index 0. The tag number is listed in the 690+ or 590+ Software Product manuals. For example Preset 1::Input 0 has tag 347, so the corresponding Index is 5000h + 347(decimal) = 515Bh. All are included in the EDS files.

Note Boolean and Enumerated tags are encoded as Unsigned8 CANopen Objects.

Enter/Exit Configuration Mode (Index 5FFFh)

When installing a complete Drive configuration over CANopen it is necessary to put the Drive into a "Configuration Mode". This mode is required if changing a parameter that is protected in Normal Mode, for example the Links in the Block Diagram.

Writing the value 35353535h ('5','5','5','5') to Index 5FFFh Sub-Index 0 will force the Drive into Configuration Mode.

Writing the value 34343434h ('4','4','4','4') to Index 5FFFh Sub-Index 0 will force the Drive into Normal Mode, i.e. Exit Configuration Mode.

SYNC Watchdog

A vendor specific feature has been included to allow a simple watchdog using the SYNC message. This can be used if there is no node in the system capable of being a Heartbeat producer or to reduce the number of messages on the bus.

The Communications Cycle Period (Index 1006h) is used to specify the expected SYNC repeat time. This is defined in microseconds. If set to 0, this feature is disabled.

The TEC OPTION function block has an output, SYNC ACTIVE. This can be used in the Block Diagram to cause the desired action if connection with the SYNC master is lost.

- The SYNC ACTIVE output is set TRUE after 10 consecutive valid SYNC messages have been received.
- The SYNC ACTIVE output is set FALSE after 5 consecutive SYNC messages have been missed.

If the feature is disabled, or the node is not in the OPERATING state, then SYNC ACTIVE is TRUE.

PEER to PEER Comms

It is possible to configure a system to operate without a NMT master. In a conventional CANopen system, the NMT node is responsible for downloading the communications parameters to each node and then changing the state of the nodes to OPERATING. The master may also have some perform some watchdog tasks for the network.

The following features are supported in the option to allow it to operate without a master:

- Communications parameters, including PDO mapping, can be saved in non-volatile memory.

These are automatically restored after a power-up or reset:

- Automatic transition to OPERATING state without need for NMT command.
- PDOs can be transmitted on data change and/or timer event
- Event timer can be used on Rx PDOs to clear data to zeroes if not being updated.

Example:

To connect a Multiplexer Function Block in a 690+ to a Demultiplexer Block in another 690+. Data transferred on change or every 10ms if not changing. If no update received within 15ms, the Demultiplexer outputs are set to FALSE.

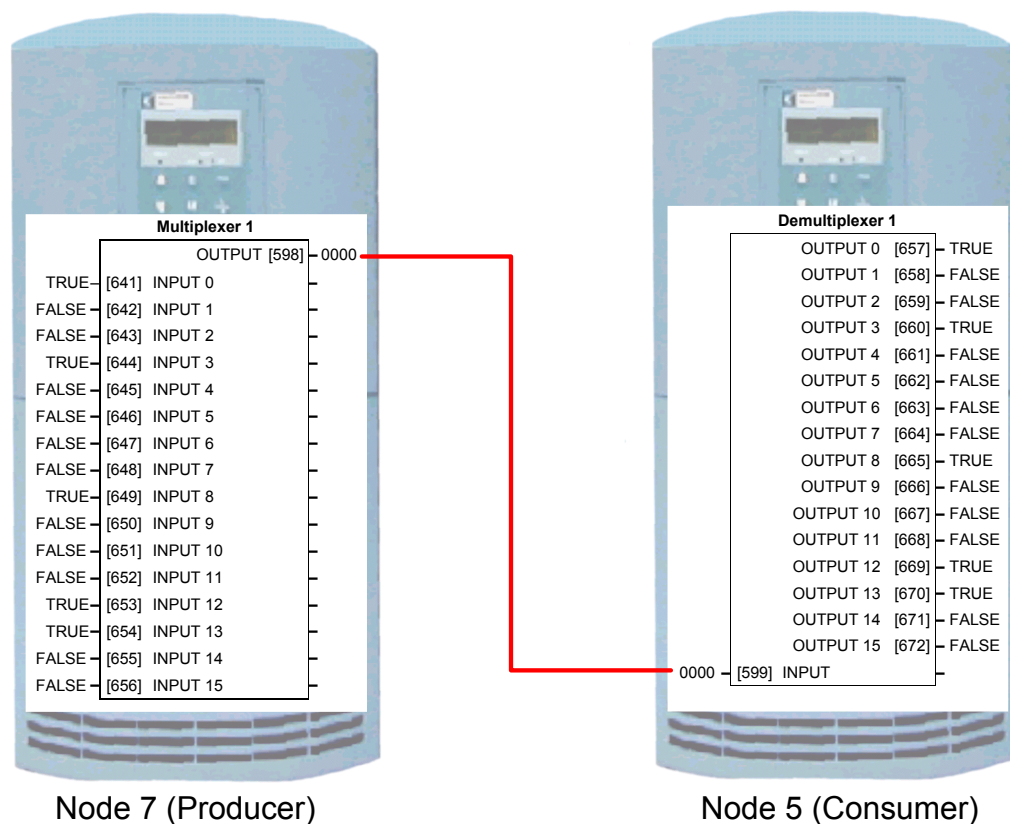
**Configure Node 5 as Consumer**

Set TEC OPTION::NODE ID to 5

Set TEC OPTION::PDO DEFAULT to NONE, this removes any previously configured mappings.

Using SDO messages, set the following Indexes:

Idx	SIdx	Name	Type	Value	Notes
1400h		receive PDO1 parameter	PDO Parameter		
	1	COB-ID	Unsigned32	187h	Same as COB-ID for Tx PDO 1 on Node 7 (180h + 7), <i>not</i> the standard COB-ID for Rx PDO 1 on Node 5
	2	transmission type	Unsigned8	254	Asynchronous update
	5	event timer	Unsigned16	000Fh	15 milliseconds - timeout
1600h		receive PDO1 mapping parameter	PDO Mapping		
	0	number of mapped objects	Unsigned8	1	1 mapped parameter
	1	1 st mapped object	Unsigned32	14890010h	Index 5257, Sub-Index 0, size 16bits - (599) demultiplexer 1::input
2018h	0	NMT_operational state	Unsigned16	0001h	Go to OPERATING mode without NMT command.
1010h		store parameters			
	2	save communications parameters	Unsigned32	73617665h	'save' signature

Set TEC OPTION::PDO DEFAULT to SAVED, this causes saved mappings to be restored after a power-up/reset.

Save drive configuration.

Configure Node 7 as Producer

Set TEC OPTION::NODE ID to 7

Set TEC OPTION::PDO DEFAULT to NONE, this removes any previously configured mappings.

Using SDO messages, set the following Indexes:

Idx	SIdx	Name	Type	Value	Notes
1800h		transmit PDO1 parameter	PDO Parameter		
	1	COB-ID	Unsigned32	187h	Same as COB-ID for Rx PDO 1 on Node 5
	2	transmission type	Unsigned8	254	Asynchronous update
	5	event timer	Unsigned16	000Ah	10 milliseconds - minimum refresh rate
1A00h		transmit PDO1 mapping parameter	PDO Mapping		
	0	number of mapped objects	Unsigned8	1	1 mapped parameter
	1	1 st mapped object	Unsigned32	14880010h	Index 5256, Sub-Index 0, size 16bits - (598) multiplexer 1::output
2018h	0	NMT_operational state	Unsigned16	0001h	Go to OPERATING mode without NMT command.
1010h		store parameters			
	2	save communications parameters	Unsigned32	73617665h	'save' signature

Set TEC OPTION::PDO DEFAULT to SAVED, this causes saved mappings to be restored after a power-up/reset.

Save drive configuration.

Done

The system is now configured and will communicate without any NMT node connected.

Available Tools

Tools are available that can help configuring a Peer to Peer network, such as the CANopen Configuration Studio by IXXAT (www.ixxat.de). This has a Visual Object Linker to manage the parameter connections between drives and to automatically configure PDOs.

Here are some screen shots of using the IXXAT tool for the above example.

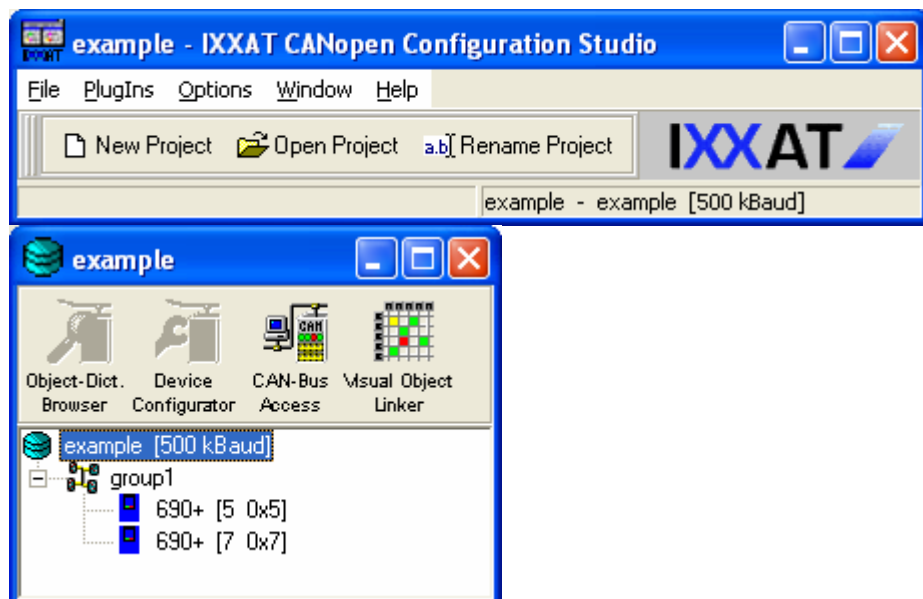

The screenshot shows the 'Link Matrix' tab in the 'example [500 kBaud] - CANopen Visual Object Linker' application. The 'Consumer' is set to '690+ [5 0x5]' and the 'Producer' is '690+ [7 0x7]'. The matrix shows a connection between object (598) multiplexer 1::output and object (599) demultiplexer 1::input, indicated by a yellow square in the matrix cell. The list of objects includes various brake control, voltage control, and multiplexer/demultiplexer objects.

The screenshot shows the 'Connection Listing' tab in the same application. It displays a table with the following data:

#	ConnectionName	COB-ID	TxNode	TxPDO#	TxObject	RxNode	RxPDO#	RxObject
1	(598) multiplexer 1::output	0x187	7	0x01	5256sub00	5	0x01	5257sub00

EMERGENCY Message

When the Drive enters or exits a Tripped state, an EMERGENCY message is sent. Also Bit zero of the Error Register (Index 1001h) is set to 1 if in the Tripped state. The following error codes are used:

690+

Note - the least significant 8-bits is the same as the FIRST TRIP parameter.























0000h	No Error
FF01h	Overvoltage
FF02h	Undervoltage
FF03h	Overcurrent
FF04h	Heatsink
FF05h	External Trip
FF06h	Input 1 Break
FF07h	Input 2 Break
FF08h	Motor Stalled
FF09h	Inverse Time
FF0Ah	Brake Resistor
FF0Bh	Brake Switch
FF0Ch	Operator Station
FF0Eh	Conactor Feedback
FF0Fh	Speed Feedback
FF10h	Ambient Temperature
FF11h	Motor Overtemperature
FF12h	Current Limit
FF14h	24V Failure
FF15h	Low Speed Over Current
FF17h	Encoder 1 Fault
FF18h	DESAT (Over Current)
FF19h	VDC Ripple
FF1Ah	Brake Short Circuit
FF1Bh	Overspeed
FF20h	Other Trip

590+

0000h	No Error
FF03h	Tripped

Troubleshooting

6053/6055 CANopen Technology Option Status LED

LED Indications		Cause/Symptom	Remedy
NETWORK	MODULE		
 (OFF)		No power at the drive.	Check and apply power to the drive.
		Technology Option not installed correctly.	Check connections between Technology Option and drive.
		Hardware fault.	If HEALTH and RUN LEDs are OFF, replace the drive, else replace the Technology Option.
		The self-test has failed.	Replace the Technology Option.
		Incorrect Technology Option fitted or selected.	Fit the correct Technology Option or select the matching value for the TYPE parameter in the TEC OPTION function block. (TYPE = CANOPEN).
		Set-up fault. A TEC OPTION parameter is out-of-range.	Select the correct value for the parameter in the TEC OPTION function block. NODE ID must be non-zero.
		Disabled	Set-up parameters invalid, see MODULE LED for reason. Check that NODE ID is not set to zero.
		Initialisation	Transient state preparing to connect to bus
		Stopped (prepared)	Network in Stopped state. Waiting for NMT command from master.
		Pre-Operational	Network in Pre-Operational state. Waiting for NMT command from master.
 (ON)		Operational	Normal Operating state.

ISS.	MODIFICATION	ECN No.	DATE	DRAWN	CHK'D
1	First release of HA467800U001.	16164	07/07/03	CM	KJ
1	First release of HA467800U002. Issue 2.x software release. Company name change	16164 (18354)	29/07/05	CM	KJ
2	Company name change	19591	30/07/07	CM	KJ
FIRST USED ON		MODIFICATION RECORD CANopen Communications Interface			
		DRAWING NUMBER ZZ467800C001			SHT. 1 OF 1